

MECHATECH
industries 

MECHATECH INDUSTRIES L.L.C

LED PROFILE ME08

Wide High Profile

Dubai ,UAE -P.O.Box :478371
Dubai Industrial City ,Phase1 -B32
Tel +971 4 4270357
Fax +971 4 4270174
info@mechatech.co
www.mechatech.co

OPTICAL & MECHANICAL PROPERTIES

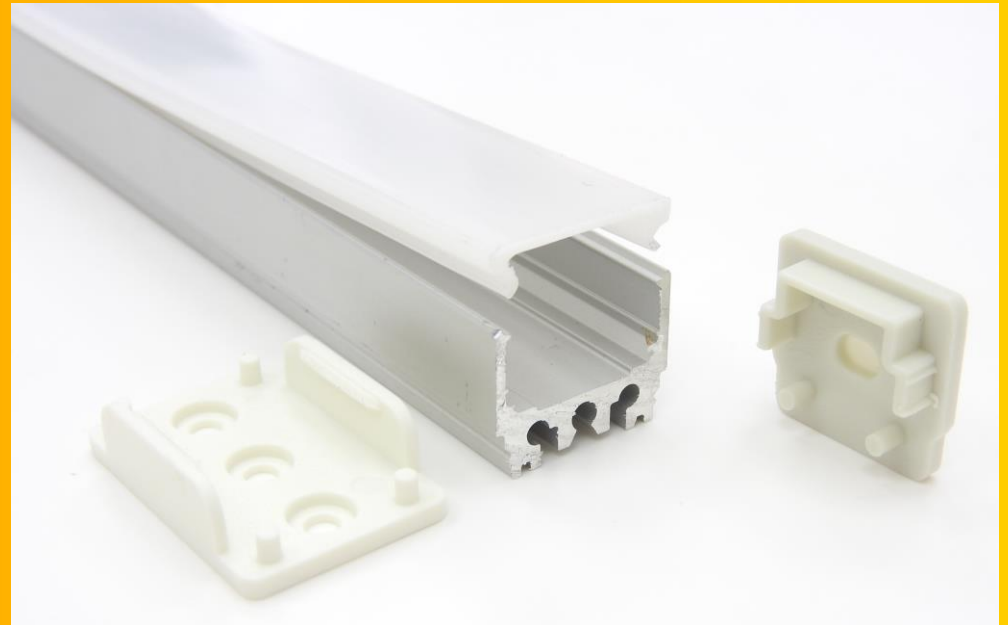

LED light has been getting used at a various Lighting applications such as lighting fixtures and LED indicator because of its low energy consumption. However, LED light is spot light source and people feels uncomfortable to the glare. Acrylic was the suitable material for diffusers to provide controlling the glare, hide the spot and convert spotlight to area light.

With great light transmission plus UV resistance and anti- yellowing feature Polycarbonate lighting grades are the new industry touchstone for LED light diffusion. Break resistant, easy to cut-to-size, reduce glare, provide pinpoint brightness and enhance visual comfort.

Polycarbonate is mainly used for electronic applications that capitalize on its collective safety features. Being a good electrical insulator and having heat-resistant and flame-retardant properties

Mechatech LED profiles has wide range of ready-made portfolio in terms of the anodized aluminum profiles, flame retardant, diffuser colors and light diffusion properties. It allows responding sudden requirements changes and last minutes' design change.

In general, the higher light diffusive material the more loss of its light, however, Mechatech LED Profiles employs proprietary technology to minimize the loss. The higher light output of the fixture can be achieved with using diffuser covers made out best optical grades of Polycarbonate.



PMMA (Acrylic) vs PC (Polycarbonate)

Thought of touching the basics

1. PMMA has 17 times the impact resistance of glass. PC has 250 times the impact resistance of glass.
 2. PMMA is very rigid whereas PC can be bought in flexible grades. Acrylic cracks more easily than polycarbonate under stress.
 3. PMMA has light transmittance of 92 percent and PC has a light transmittance of 88 percent in comparison to glass.
 4. PMMA can handle temperatures up to 90C while PC can handle temperatures up to 115C.
 5. PMMA will crack if it is drilled near an edge or with a drill bit not designed for plastic. PC typically does not crack when being drilled even if drilled close to the edge with a standard drill bit.
 6. PMMA has a low chemical resistance. PC has a higher chemical resistance than PMMA.
 7. PMMA is more likely to chip than PC because it is less impact-resistant. It does not scratch easily, however, PC will not yellow over time.
 8. PC has no flammability, while PMMA will burn slowly like a candle and is not recommended in areas where flames may be present.
 9. PC is more expensive than PMMA. It tends to cost about 45% more
-

FEATURES & TECHNICAL DETAILS

Overview

ME Series Aluminum profiles/channel is made of sturdy anodized aluminum metal, and has a specific design to protect LED strip and create softer lighting effect.

Aluminum profile/channel is a great housing and excellent heat sink for flexible LED strips. The profile is widely used for under cabinet, under stairs, closets. Exhibits furniture, workstations, or any other visible installations where the strips lighting is exposed. The profiles are supported by snap on covers in Clear, Opal matt and Frosted diffusers

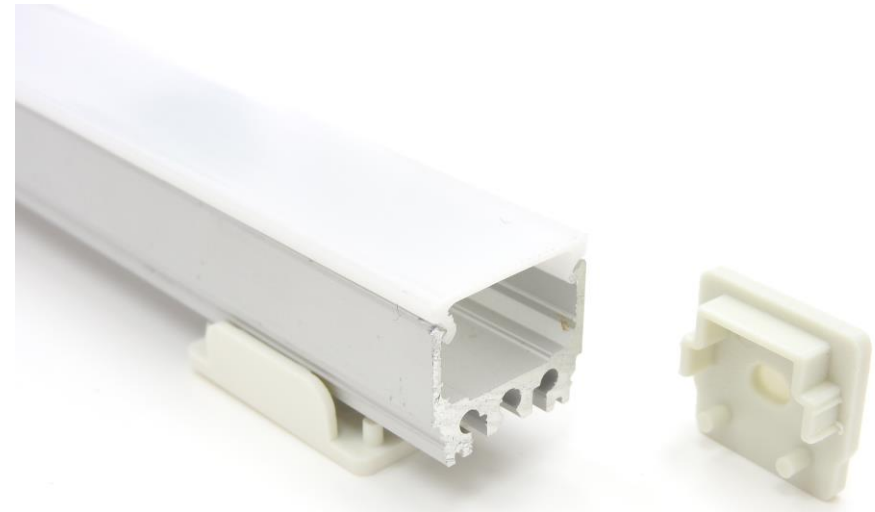

Features

- Premium quality extruded anodized Aluminum
- Compatible with 8mm, 10mm, 12mm LED strips
- Premium quality PC light diffusers
- Excellent Heat sink
- Recessed model

Technical Details

Finish	Anodized Silver
Standard Length	2000mm
Max Length	6000mm
Accessories	End Caps/Mounting Brackets
Mounting Brackets	Fixed – Adjustable 15-30-45 Degrees
Diffuser Option	Clear/Frosted/Opal
Use	Indoor/Outdoor

**LEXAN™ COPOLYMER POLYCARBONATE RESINS
OPTICAL PROPERTIES FOR DIFFUSERS**



Thickness	Item	TRANSPARENT	FROSTED	OPAL 2%	OPAL 3%
1.2mm	Transmission%	90.2	83.5	73	67.5
	DLD		17.9	32.8	47.1
	Haze%	0.7	97.7	98.6	99
1.0mm	Transmission%	90.8	87.6	81.3	76.5
	DLD		12.7	19.8	30.5
	Haze%	0.6	96.8	98.2	98.6

DIMENSIONS

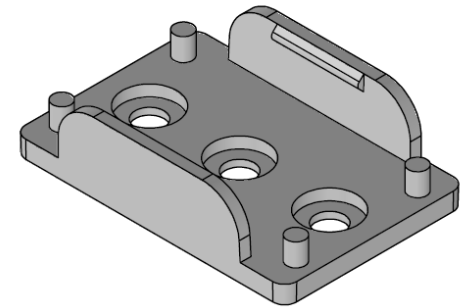
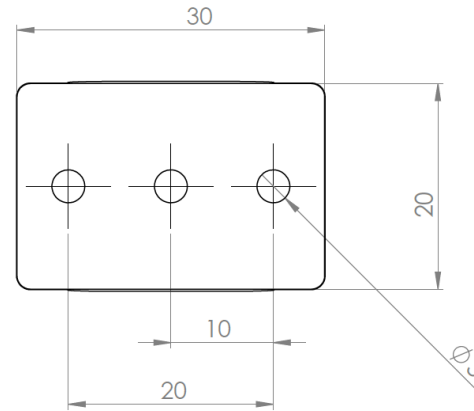
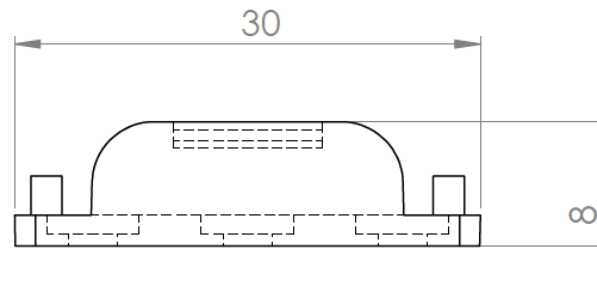
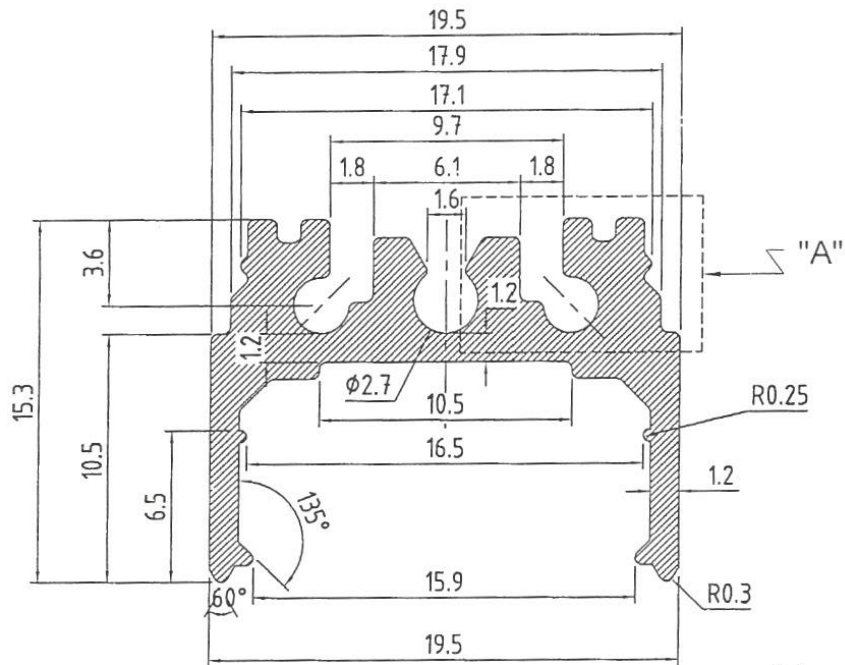

PACKAGING

Item	Quantity in Box	Box Weight	Box Dimensions
ME08 Anodized Aluminum Profile	100 PCs x 2m each=200m	54 Kg	2000x170x170mm
D (C-F-O)08 PC Diffuser	250 PCs x 2m each =500m	22 Kg	2000x170x170mm

ADJUSTABLE MOUNTING BRACKET

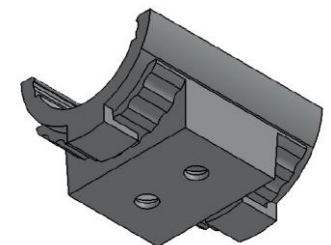
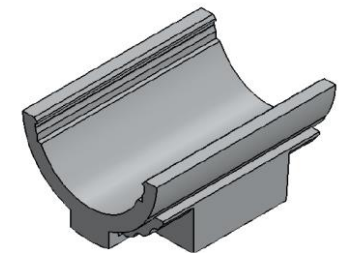
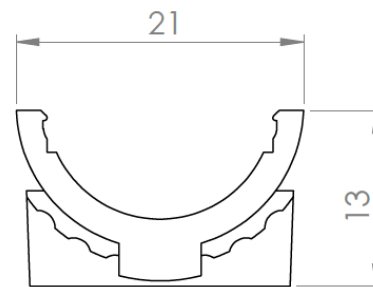
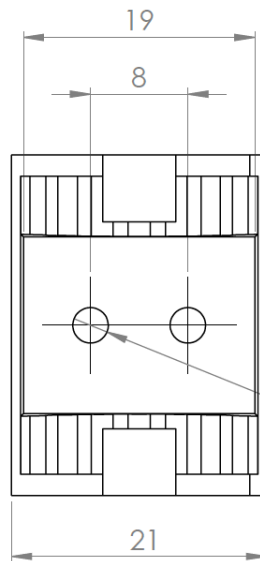
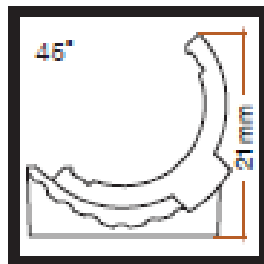
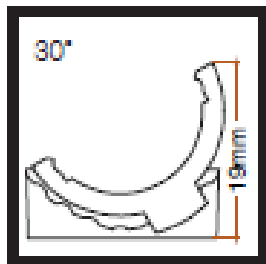
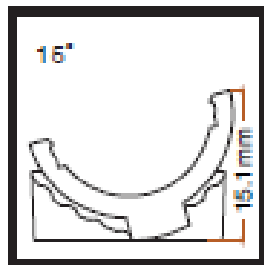
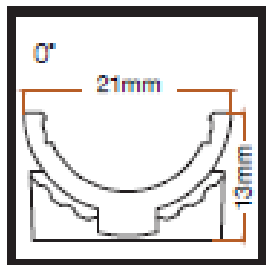

PROPERTIES OF LEXAN™ RESIN FROSTED & OPAL

LEXAN (PC) resin frosted is a non-filled, extricable grade. This non-chlorinated, non-brominated flame retardant PC has an UL-94 V0 rating at 1.0 mm / 5VA rating at 3.0mm and is UV stabilized (F1 rating) providing additional weathering capability.

TYPICAL PROPERTIES ¹	TYPICAL VALUE	Unit	Standard
MECHANICAL			
Tensile Stress, yld, Type I, 50 mm/min	630	kgf/cm ²	ASTM D 638
Tensile Stress, brk, Type I, 50 mm/min	610	kgf/cm ²	ASTM D 638
Tensile Strain, yld, Type I, 50 mm/min	7	%	ASTM D 638
Tensile Strain, brk, Type I, 50 mm/min	91	%	ASTM D 638
Tensile Modulus, 50 mm/min	23400	kgf/cm ²	ASTM D 638
Flexural Stress, yld, 1.3 mm/min, 50 mm span	990	kgf/cm ²	ASTM D 790
Flexural Modulus, 1.3 mm/min, 50 mm span	24100	kgf/cm ²	ASTM D 790
IMPACT			
Izod Impact, notched, 23°C	84	cm-kgf/cm	ASTM D 256
Izod Impact, notched, -30°C	11	cm-kgf/cm	ASTM D 256
Instrumented Impact Energy @ peak, 23°C	734	cm-kgf	ASTM D 3763
THERMAL			
Vicat Softening Temp, Rate B/50	145	°C	ASTM D 1525
HDT, 0.45 MPa, 6.4 mm, unannealed	141	°C	ASTM D 648
HDT, 1.82 MPa, 6.4 mm, unannealed	127	°C	ASTM D 648
CTE, -40°C to 40°C, flow	6.6E-05	1/°C	ASTM E 831
CTE, -40°C to 40°C, xflow	6.7E-05	1/°C	ASTM E 831
PHYSICAL			
Specific Gravity	1.2	-	ASTM D 792
Density	1.2	g/cm ³	ASTM D 792
Mold Shrinkage, flow, 3.2 mm (5)	0.6 - 0.9	%	SABIC Method
Melt Flow Rate, 300°C/1.2 kgf	3.2	g/10 min	ASTM D 1238

PROPERTIES OF LEXAN™ RESIN TRANSPARENT

LEXAN (PC) transparent resin is a non-filled resin, suitable for injection molding and extrusion. This non-chlorinated, non-brominated flame retardant PC has an UL-94 V0 rating at 1.0 mm / 5VA rating at 3.0mm and is UV stabilized (F1 rating) providing additional weathering capability.

TYPICAL PROPERTIES ¹	TYPICAL VALUE	Unit	Standard
MECHANICAL			
Tensile Stress, yld, Type I, 50 mm/min	690	kgf/cm ²	ASTM D 638
Tensile Stress, brk, Type I, 50 mm/min	530	kgf/cm ²	ASTM D 638
Tensile Strain, yld, Type I, 50 mm/min	6	%	ASTM D 638
Tensile Strain, brk, Type I, 50 mm/min	51	%	ASTM D 638
Tensile Modulus, 50 mm/min	25400	kgf/cm ²	ASTM D 638
Flexural Stress, yld, 1.3 mm/min, 50 mm span	1080	kgf/cm ²	ASTM D 790
Flexural Modulus, 1.3 mm/min, 50 mm span	24400	kgf/cm ²	ASTM D 790
Tensile Stress, yield, 50 mm/min	67	MPa	ISO 527
Tensile Stress, break, 50 mm/min	52	MPa	ISO 527
Tensile Strain, yield, 50 mm/min	6	%	ISO 527
Tensile Strain, break, 50 mm/min	23	%	ISO 527
Tensile Modulus, 1 mm/min	2400	MPa	ISO 527
Flexural Stress, yield, 2 mm/min	103	MPa	ISO 178
Flexural Modulus, 2 mm/min	2500	MPa	ISO 178
IMPACT			
Izod Impact, unnotched, 23°C	NB	cm-kgf/cm	ASTM D 4812
Izod Impact, unnotched, -30°C	NB	cm-kgf/cm	ASTM D 4812
Izod Impact, notched, 23°C	10	cm-kgf/cm	ASTM D 256
Izod Impact, notched, -30°C	8	cm-kgf/cm	ASTM D 256
Instrumented Impact Total Energy, 23°C	673	cm-kgf	ASTM D 3763
Izod Impact, unnotched 80*10*3 +23°C	NB	kJ/m ²	ISO 180/1U
Izod Impact, unnotched 80*10*3 -30°C	NB	kJ/m ²	ISO 180/1U